

# NESTOR & ROTSEN

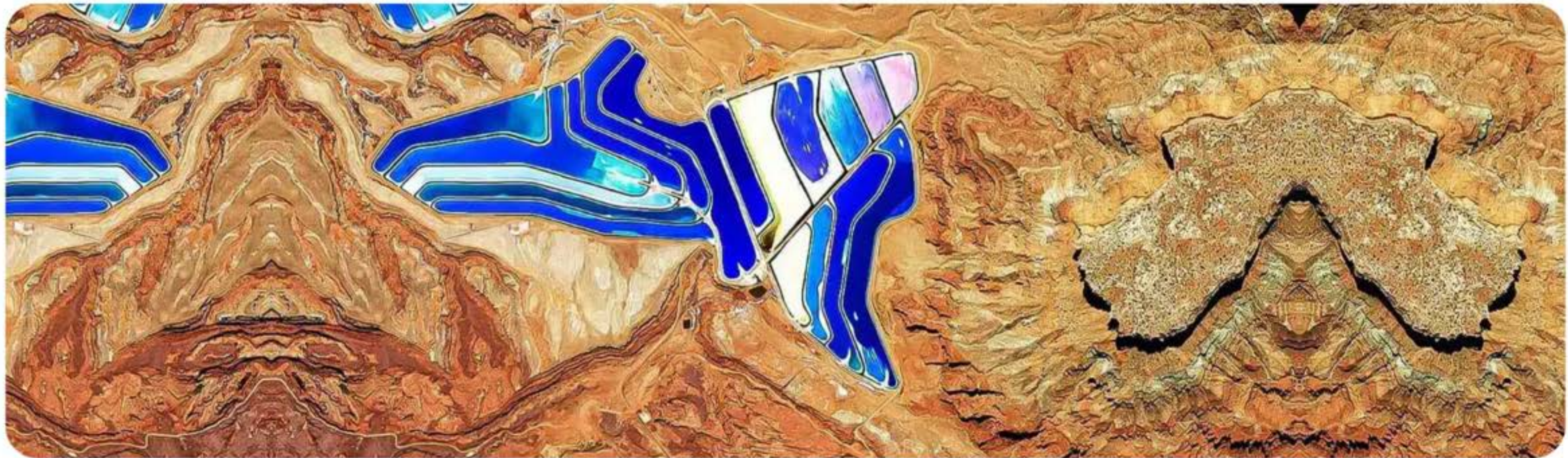

SHELBY COLLECTION  
Limited Edition

Prices on Request 2024



We are

# Textures in shapes

Natural materials, pure lines and artisanal techniques. Nestor & Rotsen combines a passion for art with craft and enthusiasm. The aim? To design and create inspiring objects & spaces that mirror the beauty of natural imperfection. Thanks to a passionate love for organic shapes, aesthetic artistry & handmade luxury.

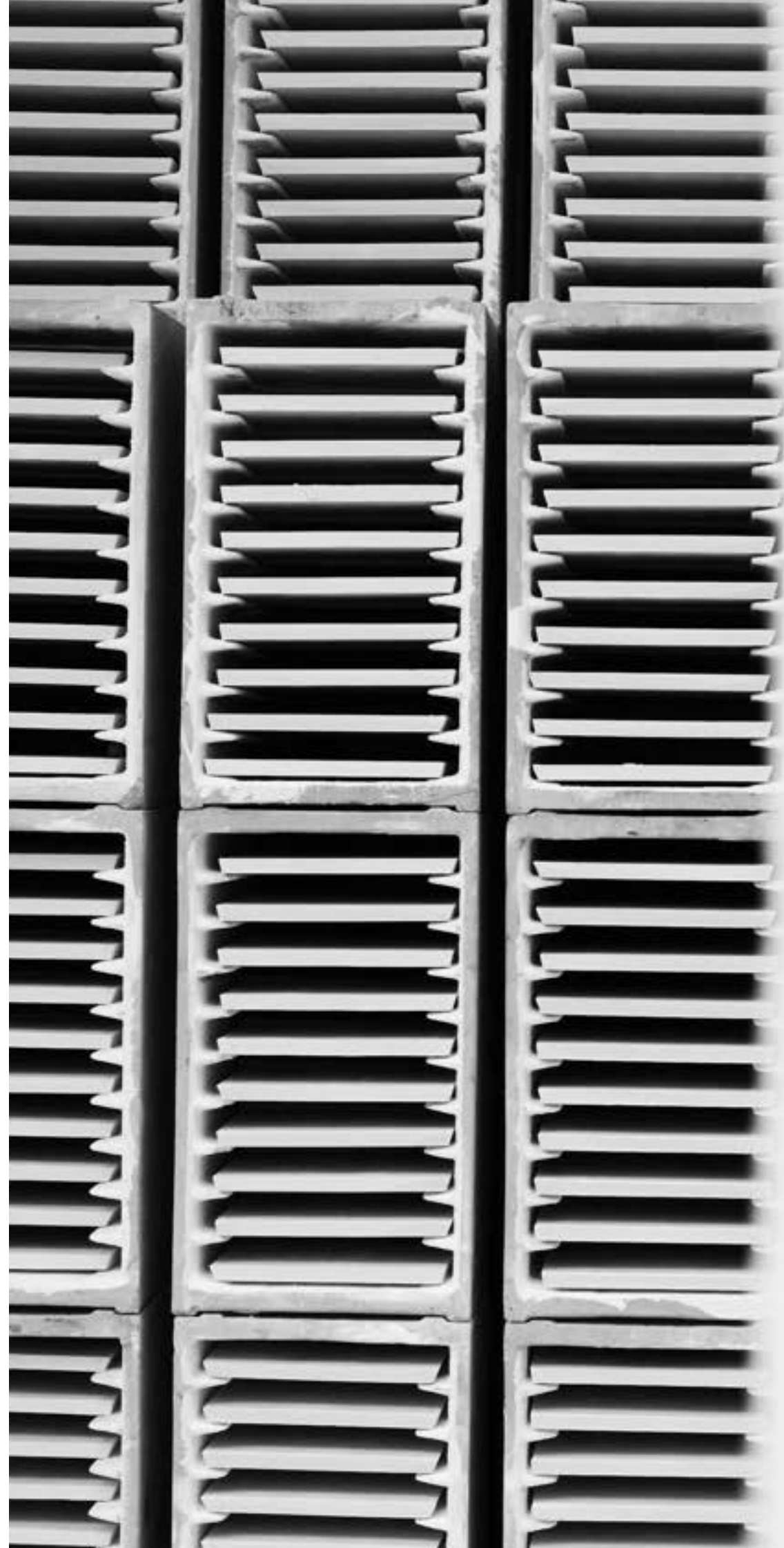

# The natural beauty of organic shapes



Owner Nestor & Rotsen | Art Director, Devi Vervaeke

The story of Nestor & Rotsen began with Devi Vervaeke, whose passion for material development ignited during his formative years. Growing up as the children of an painter and the grandchildren of a skilled furniture craftsman, Devi and his brother Denneb were immersed in a world of creativity from a young age. Despite pursuing different educational paths — Devi as a contemporary classical pianist and composer, and Denneb as a graphic designer — their shared love for materials brought them together after completing their studies. In their quest to explore their artistic roots, the brothers embarked on a journey of material experimentation. Denneb nurtured the growth of their patina workshop, while Devi began sculpting with various materials. It wasn't long before he discovered the captivating allure of ceramics, inspired by the textures, colors, shapes, and organic erosions found in nature. This revelation sparked a vision that soon blossomed into an extraordinary collection, unlike anything seen before — Nestor & Rotsen.

Since those early days, Nestor & Rotsen has evolved into a renowned design studio worldwide and a thriving workshop where their unique creations come to life, together with their strong creative team.

The world has taken notice, and their captivating designs have garnered global acclaim.

Today, Nestor & Rotsen stands as a testament to the harmonious marriage of natural materials and innovative techniques. Their exclusive objects embody organic forms and celebrate the beauty of imperfections, paying homage to the perfect balance found in nature's artistry.



Sales | Production,  
Barbara Deriemaeker



Technical Designer  
Matthijs Delbaere



Designer | R&D manager  
Jielt Gregoire



Coordination | Sales  
Virze Stallaert



Brothers Devi owner (Nestor & Rotsen)  
& Denneb owner (Atelier Nest)

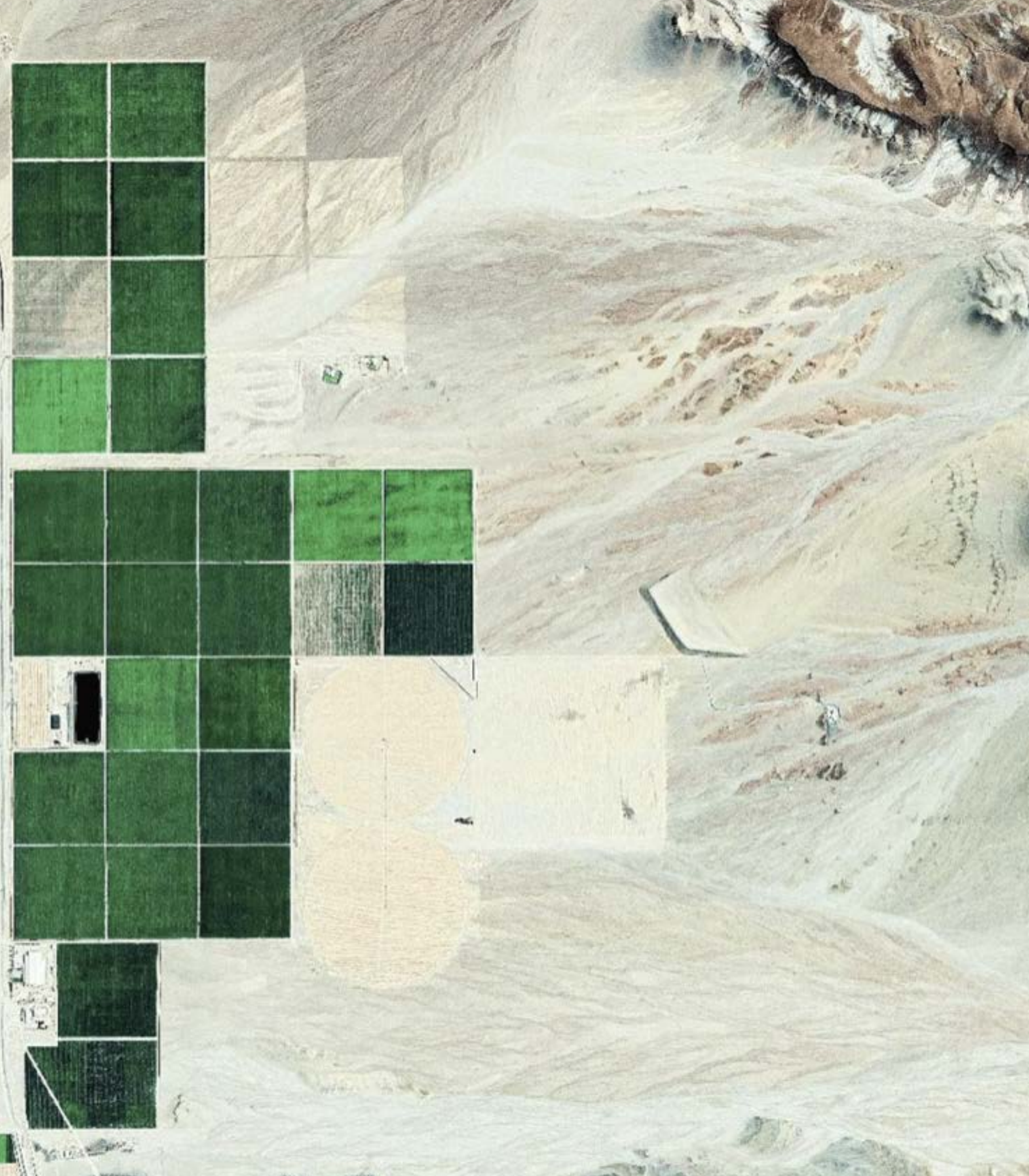

# Discover our Shelby Collection

Welcome to the enchanting world of the 'Shelby Collection' by Nestor & Rotsen, where furniture art and craftsmanship come together in perfect harmony.

This collection pays homage to the unique power of handmade ceramics, a material never before seen in the world of furniture in this form. The ceramic creations, with their graceful curves and intricate structures, exude a unique allure that challenges the boundaries of aesthetics.

The 'Shelby Cabinet,' as the centerpiece of this collection, is now joined by companions that share the same impressive allure. The 'Shelby Dinner Table' breathes life into conversations, while the 'Shelby Coffee Table' and 'Shelby Hanging Cabinet' each contribute to the refined character of the space in their own way. The 'Shelby Floor Cabinet' adds subtle yet unmistakable beauty to this assortment.

The 'Shelby Collection' is a tribute to both traditional craftsmanship and modern creativity. Each piece is infused with the spirit of Nestor & Rotsen, whose vision of furniture design guides these masterpieces. This collection embodies not only functionality but also an aesthetic that is simultaneously timeless and contemporary.

Stroll through the 'Shelby Collection' and experience the magic of handmade ceramics. Discover how these creations elevate and transform your space, while simultaneously paying homage to the creative spirit of Nestor & Rotsen and the boundless imagination that inspired Devi Vervaeke owner & founder of Nestor & Rosten. Let yourself be enchanted by the 'Shelby Collection' and create an environment that embraces elegance, innovation, and beauty.



# Shelby Cabinet





# SEA- FOAM TONES



# Shelby Cabinet

Introducing the 'Shelby' – where exceptional design and masterful craftsmanship converge, a true masterpiece brought to life by Nestor & Rosten. Paying homage to the renowned and influential vintage and race car designer Carroll Shelby, this extraordinary creation embodies power, sophistication, and timeless beauty.

Prepare to be captivated by the 'Shelby' cabinet, a harmonious blend of bold presence and graceful curves. Its meticulously handcrafted ceramic surfaces are a testament to artistry and ingenuity, pushing the boundaries of what is possible. The imposing feet, crafted from a single piece of ceramic, exude opulence, available in your choice of luxurious gold or striking copper.

*Designed by N&R Owner Devi Vervaeke*





# Shelby Cabinet

Every detail has been carefully considered, leaving no aspect to chance. The 'Shelby' cabinet is enveloped entirely in ceramic, including its bottom and back, allowing it to take center stage in any space. Step inside, and you'll discover a meticulously finished interior adorned with lustrous brass accents, though options of copper or veneer are also available, tailored to your preferences.





# OFF- WHITE TONES

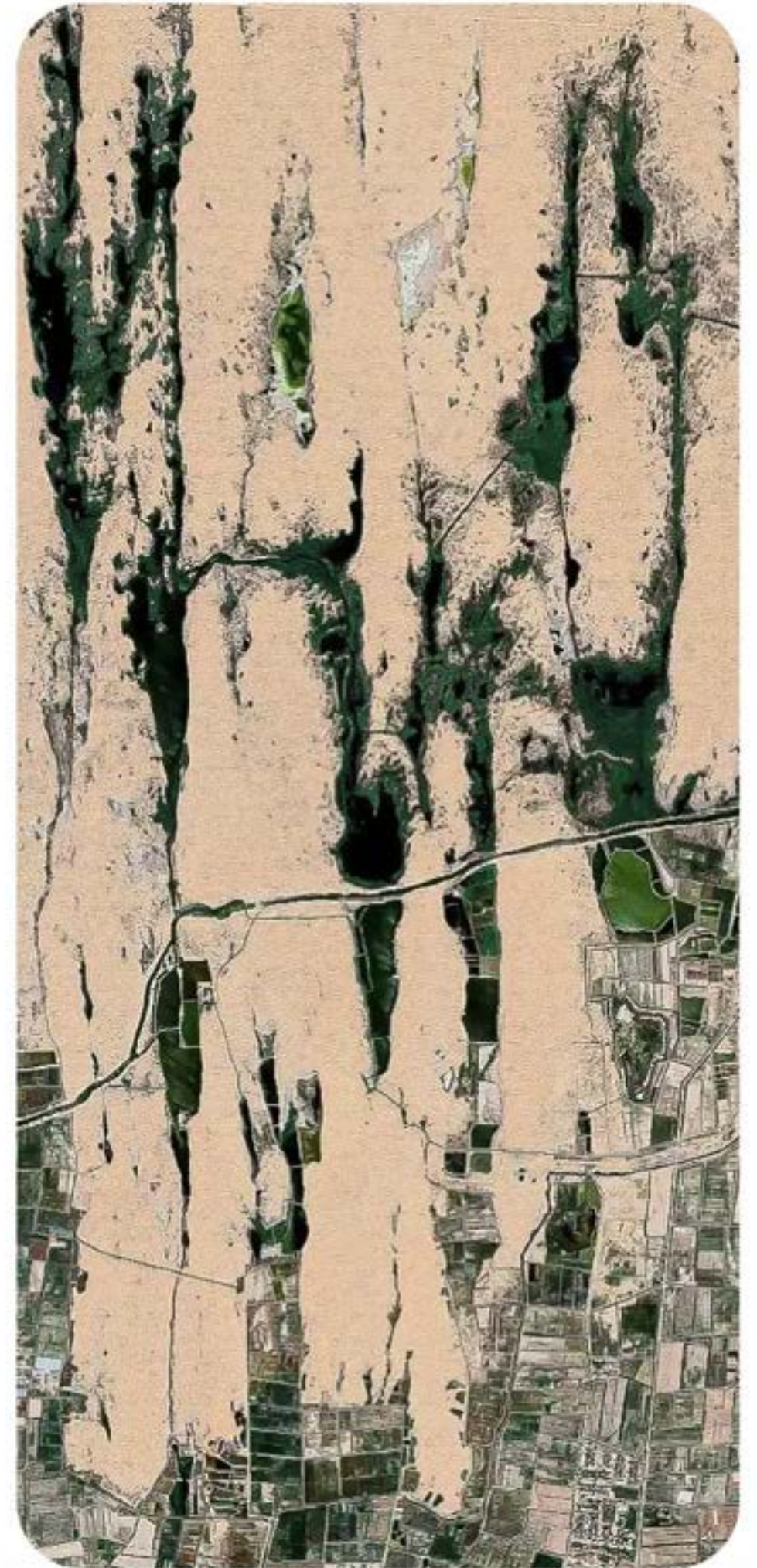



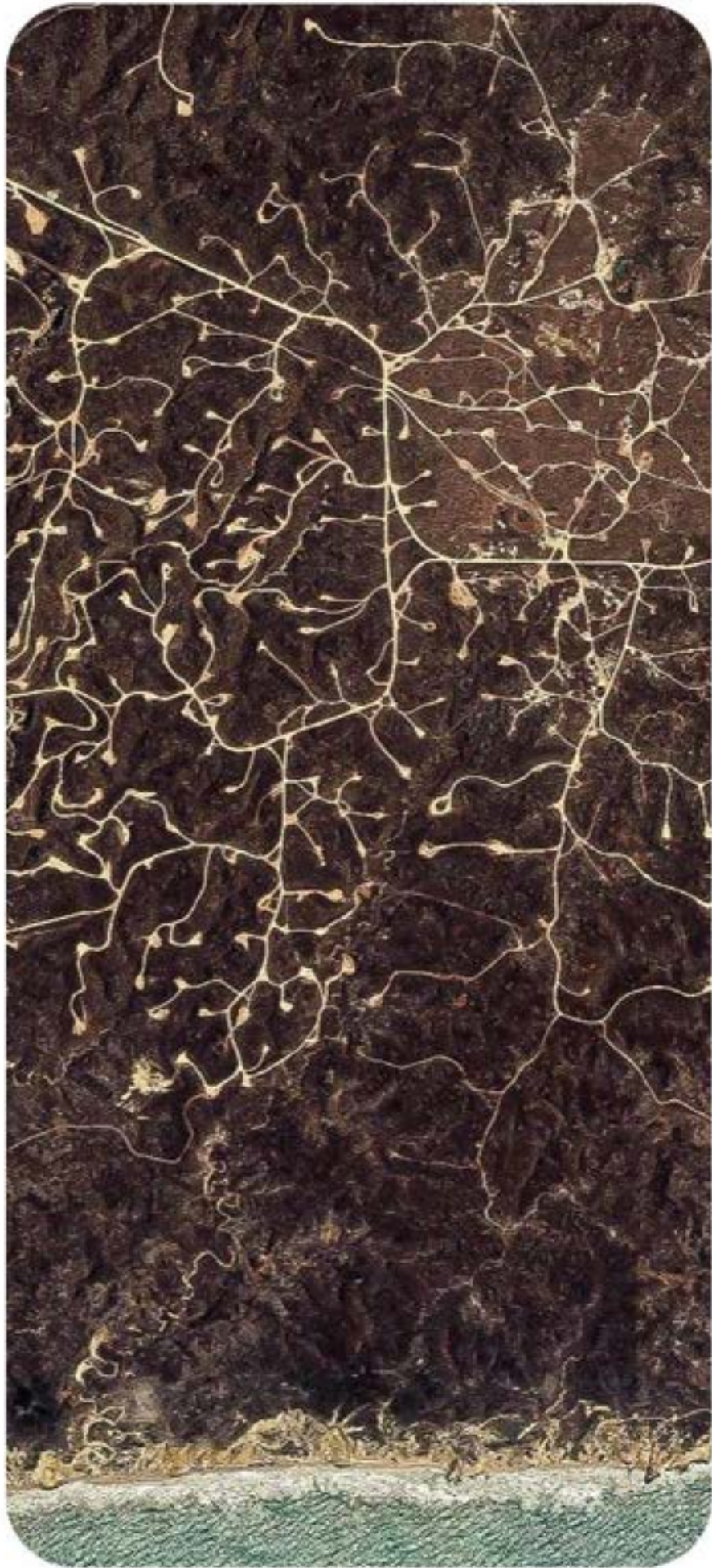

# BRONZE TONES







# Shelby Cabinet

## Inside finishes & feet

Messing

Silver

Rose copper

Versatility meets elegance, as the 'Shelby' comes in a range of sizes to suit your specific needs. The possibilities for personalization are endless, with a myriad of glazed colors to choose from. Whether it graces your living room, study, or gallery, the 'Shelby' commands attention and embodies the essence of refined luxury.



N&R

# Shelby Cabinet

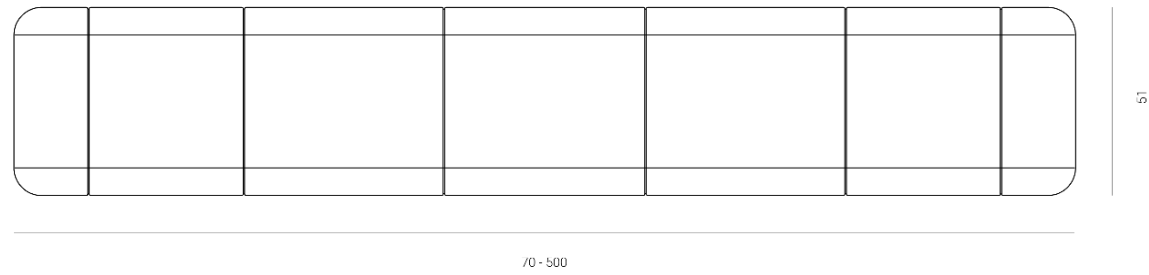

70 - 500

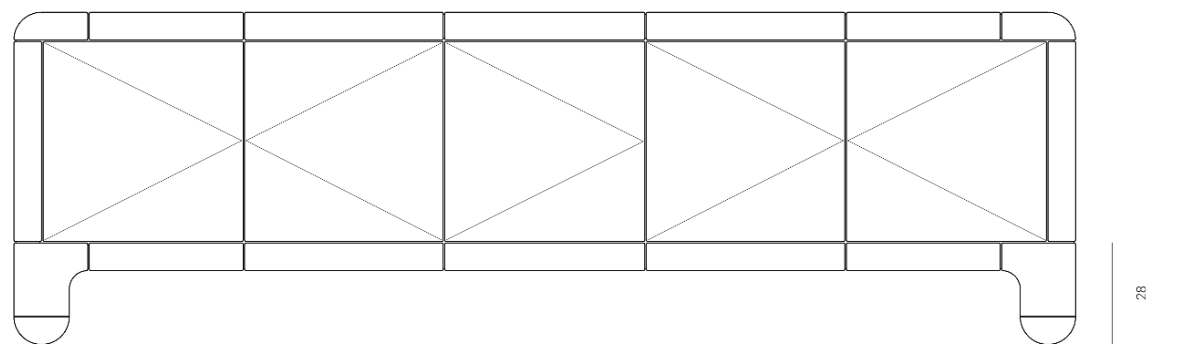
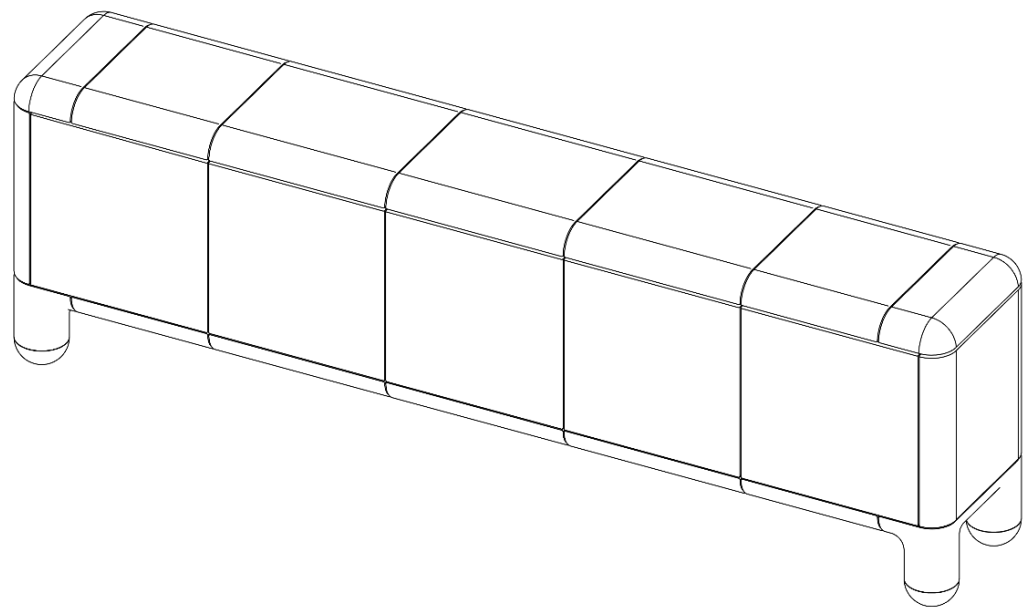

90

Technical drawing & available colors

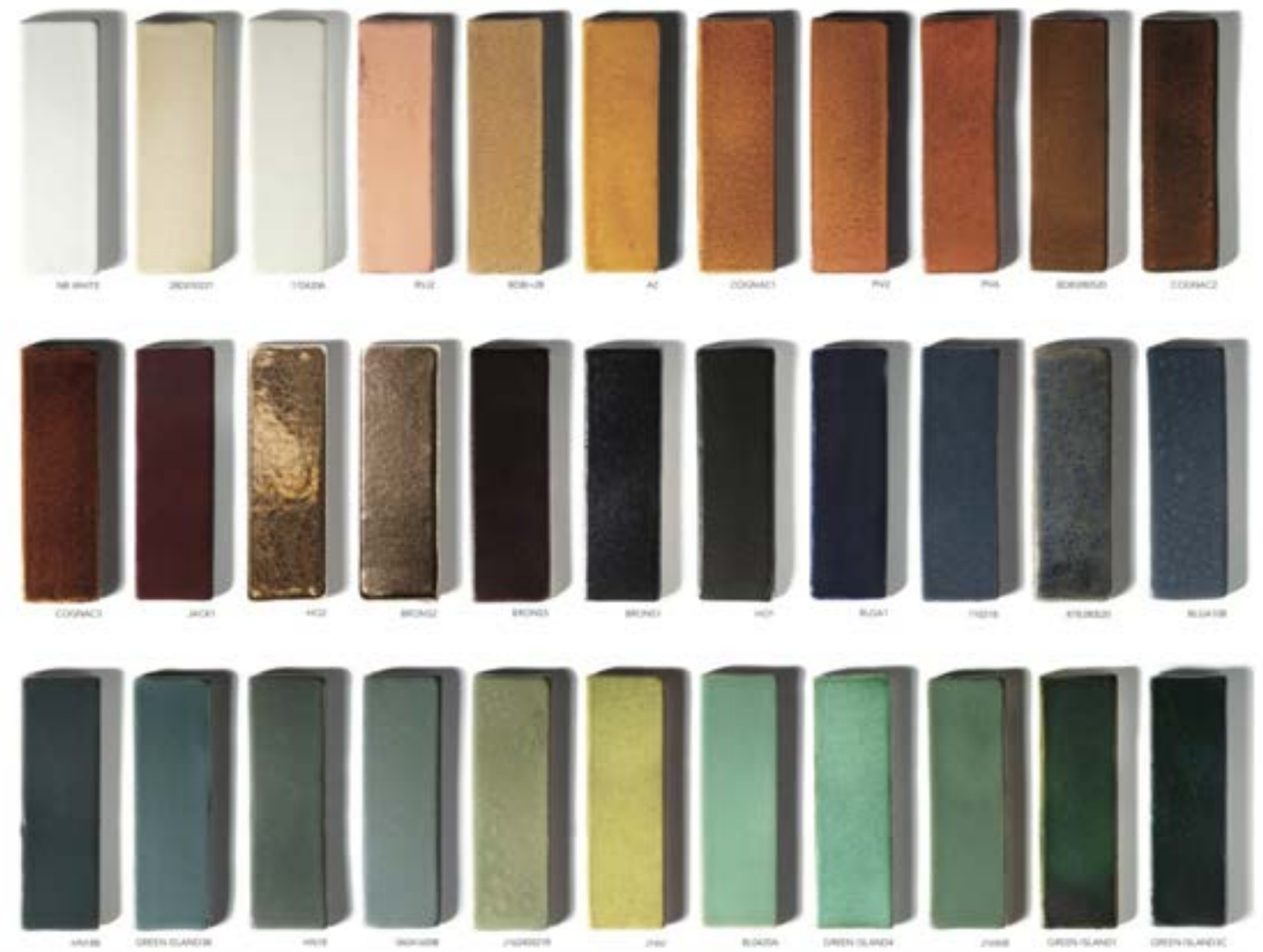

# Shelby Cabinet

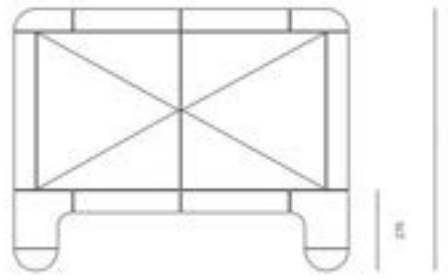

105

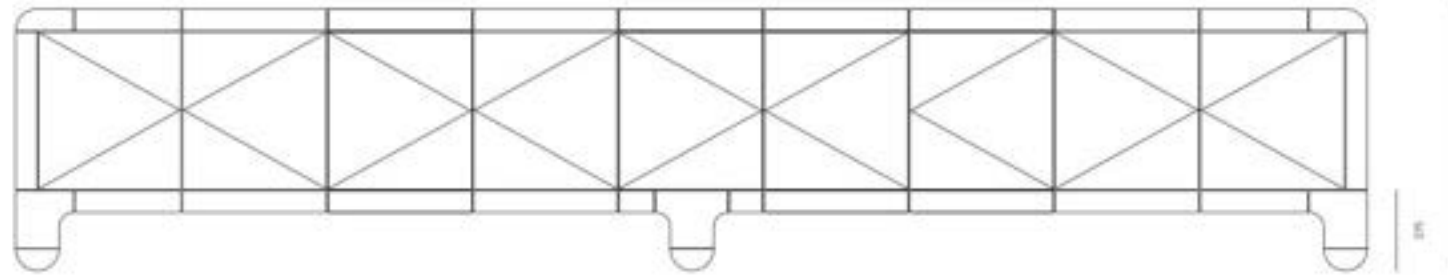

450

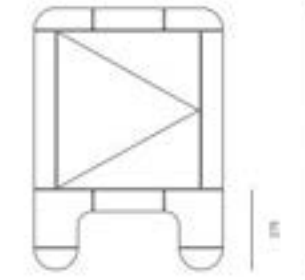

70

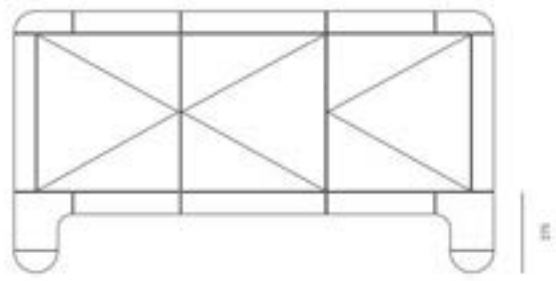

150

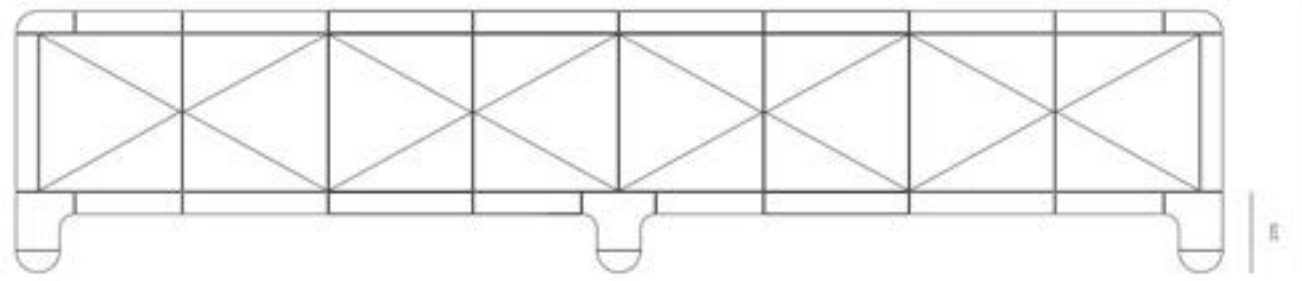

395

Size in cm  
custom dimensions on request

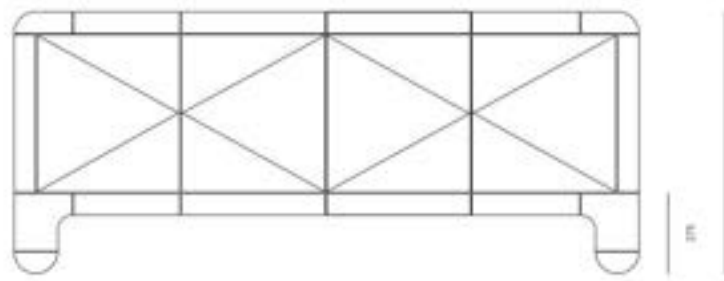

180

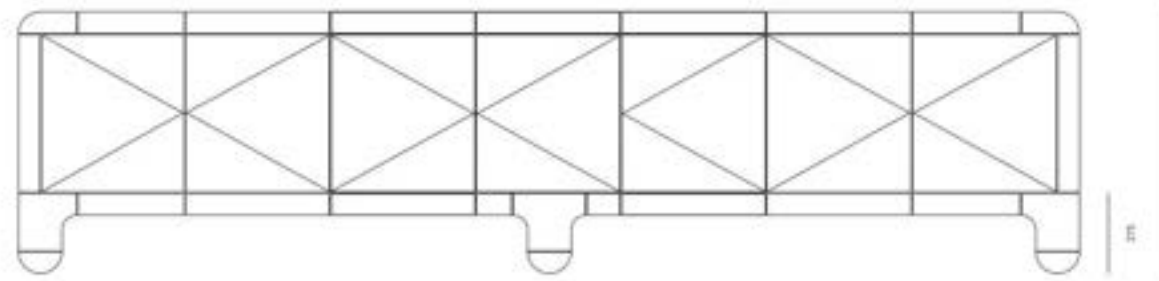

345

L. 70 | B. 51 | H. 90

1 door

L. 125 | B. 51 | H. 90

2 doors

L. 180 | B. 51 | H. 90

3 doors

L. 235 | B. 51 | H. 90

4 doors

L. 290 | B. 51 | H. 90

5 doors

L. 345 | B. 51 | H. 90

6 doors

L. 395 | B. 51 | H. 90

7 doors

L. 450 | B. 51 | H. 90

8 doors

L. 505 | B. 51 | H. 90

9 doors

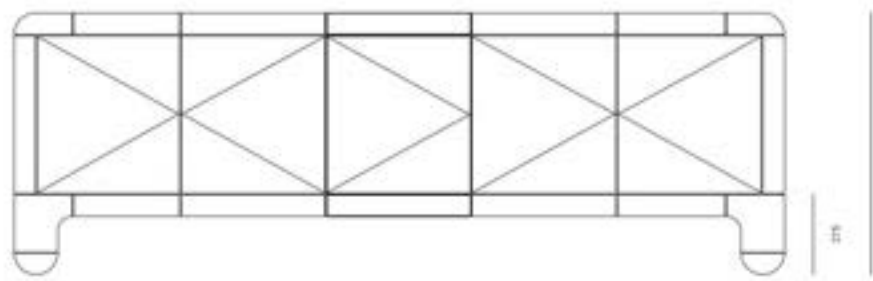

235

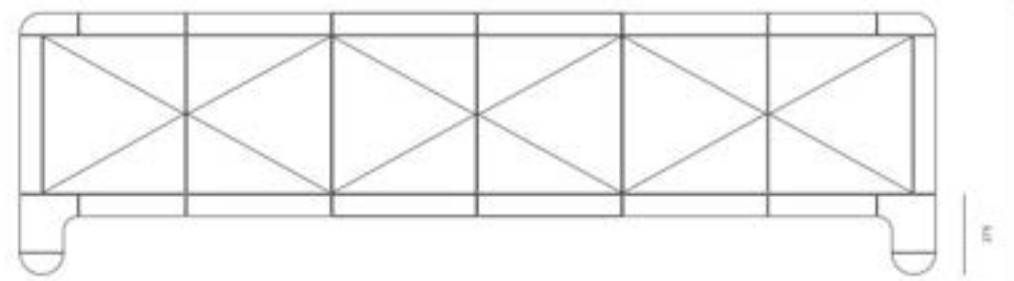

290



# Shelby Cabinet



*Material*  
custom materials on request

Ceramic shell  
Standard: Copper-Messing-Silver

*Colors*  
custom finishes on request

36 colors available  
Natural or dark oiled

*Size in cm*  
custom dimensions on request

L. 70 | B. 51 | H. 90  
1 door  
L. 125 | B. 51 | H. 90  
2 doors  
L. 180 | B. 51 | H. 90  
3 doors  
L. 235 | B. 51 | H. 90  
4 doors  
L. 290 | B. 51 | H. 90  
5 doors  
L. 345 | B. 51 | H. 90  
6 doors  
L. 395 | B. 51 | H. 90  
7 doors  
L. 450 | B. 51 | H. 90  
8 doors  
L. 505 | B. 51 | H. 90  
9 doors

*Price excl. VAT*  
excl. transport

Prices on request

# Shelby Dinner Table



Introducing the 'Shelby Dinner Table' – a captivating fusion of art and function from Nestor & Rotsen. Crafted with meticulous attention to detail, this table marries handcrafted ceramic artistry with contemporary design. Its sleek lines and unique ceramic surface make a bold statement, while its inviting ambiance sets the stage for unforgettable dining moments.

Gather your loved ones around the 'Shelby Dinner Table' and immerse yourselves in the beauty of its craftsmanship. The ceramic surface, a testament to Nestor & Rotsen's dedication to excellence, offers a tactile and visual feast. Available in a range of captivating hues, this table invites you to tailor your dining space to your personal aesthetic.

Whether hosting an intimate dinner or a grand feast, the 'Shelby Dinner Table' transforms any occasion into an elegant affair. Elevate your dining experience and create lasting memories with a piece that exudes sophistication, creativity, and the artistry of Nestor & Rotsen.

*Designed by N&R Owner Devi Vervaeke*

# Shelby Dinner Table



# Shelby Dinner table



# Shelby Dinner Table

Finishes feet

Messing

Silver

Rose copper



# Shelby Dinner Table

Technical drawing & Available Colors

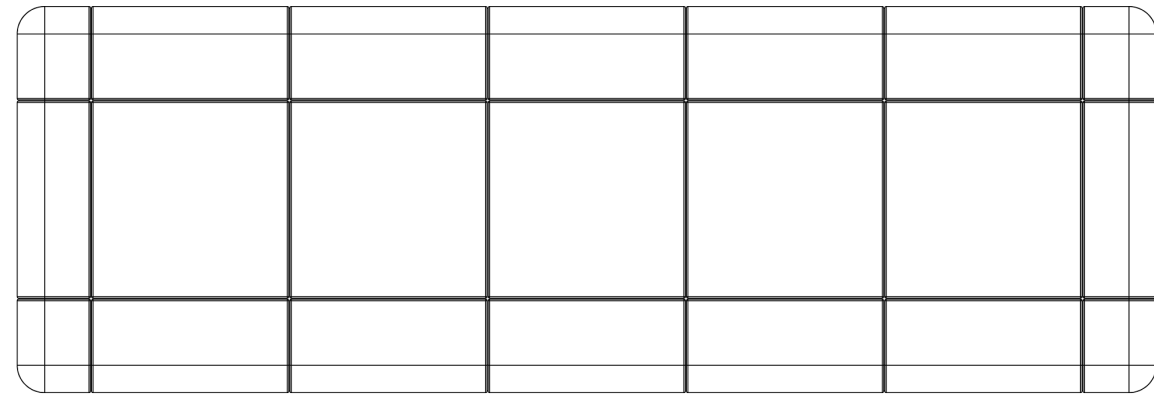

95 - 581

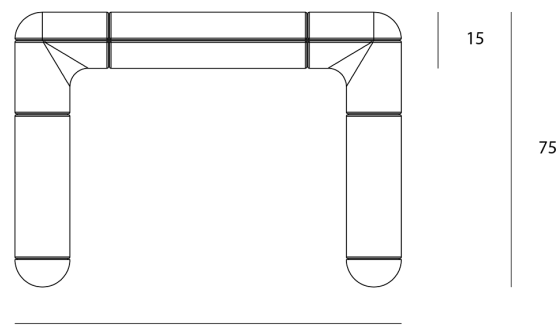
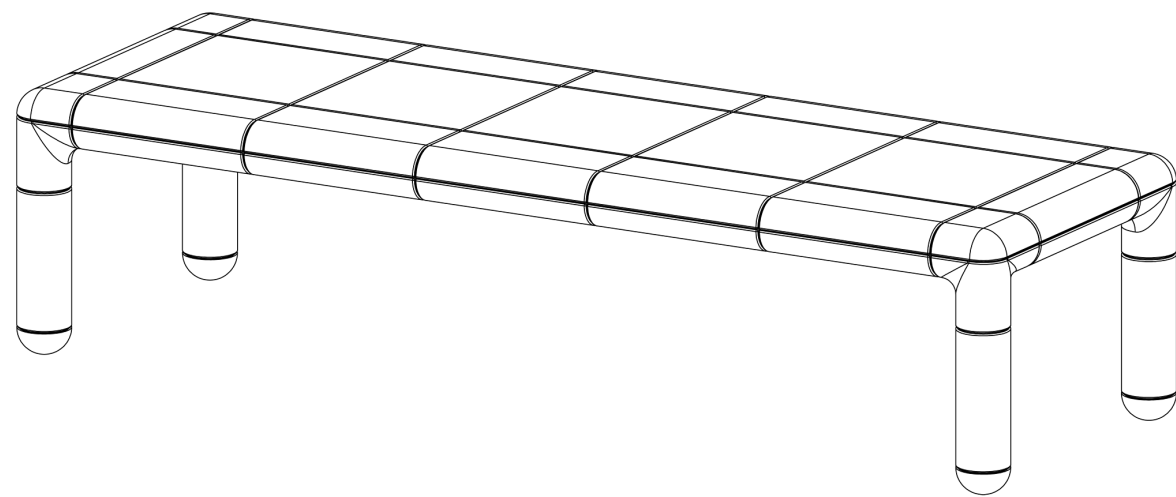

105

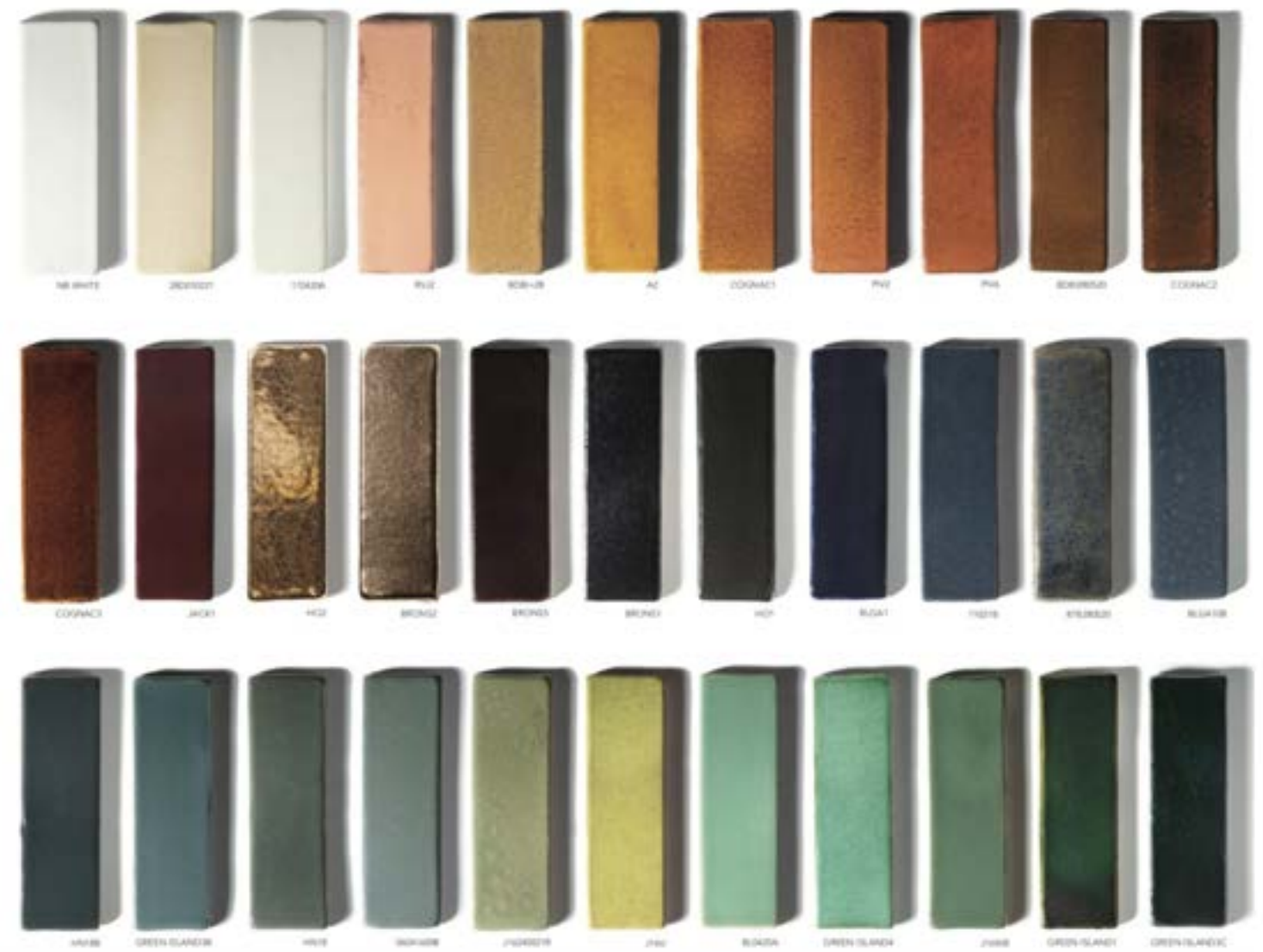

# Shelby Dinner Table

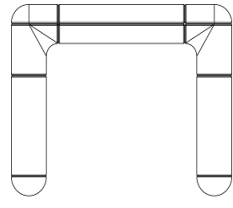

105

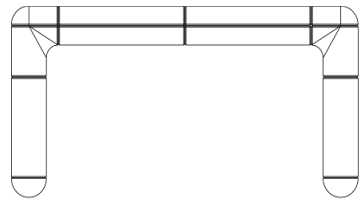

150



205



260



305

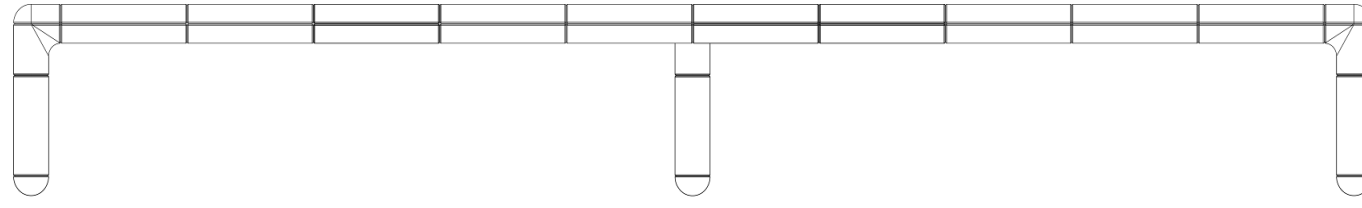

580

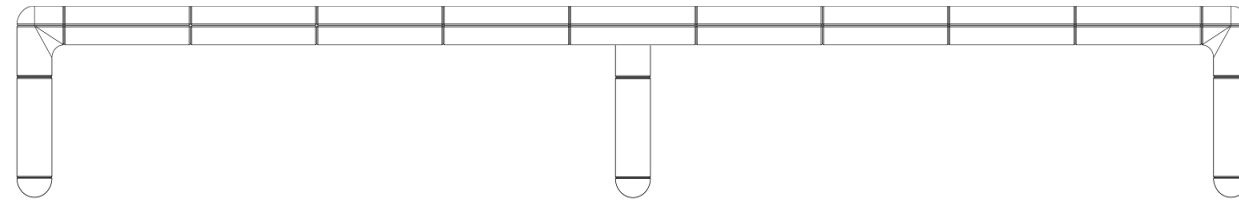

525

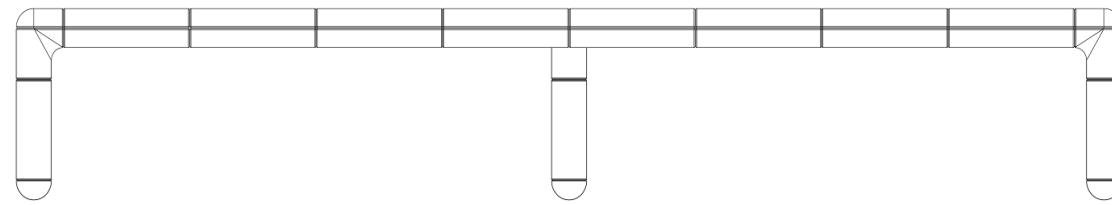

470

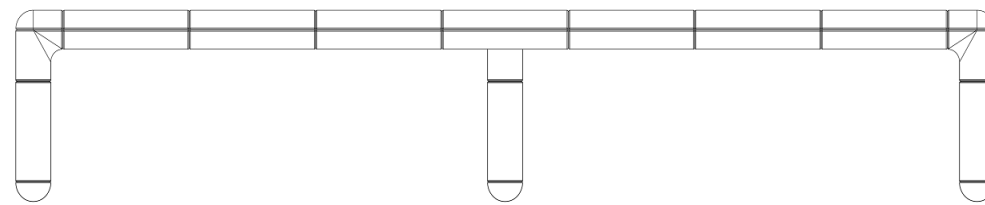

415



360

*Size in cm  
custom dimensions on request*

L. 105 | B. 95 | H. 75

L. 150 | B. 105 | H. 75

L. 205 | B. 105 | H. 75

L. 260 | B. 105 | H. 75

L. 305 | B. 105 | H. 75

L. 360 | B. 105 | H. 75

L. 415 | B. 105 | H. 75

L. 470 | B. 105 | H. 75

L. 525 | B. 105 | H. 75

L. 580 | B. 105 | H. 75

# Shelby Dinner Table



*Material*  
custom materials on request

Ceramic shell  
Standard: Copper-Messing-Silver

*Colors*  
custom finishes on request

36 colors available  
Natural or dark oiled

*Size in cm*  
custom dimensions on request

*Price excl. VAT*  
excl. transport

L. 105 | B. 95 | H. 75

Prices on request

L. 150 | B. 105 | H. 75

L. 205 | B. 105 | H. 75

L. 260 | B. 105 | H. 75

L. 305 | B. 105 | H. 75

L. 360 | B. 105 | H. 75

L. 415 | B. 105 | H. 75

L. 470 | B. 105 | H. 75

L. 525 | B. 105 | H. 75

L. 580 | B. 105 | H. 75





**Order your samples  
on our webshop**

[www.nestor-rotsen/shop](http://www.nestor-rotsen/shop)

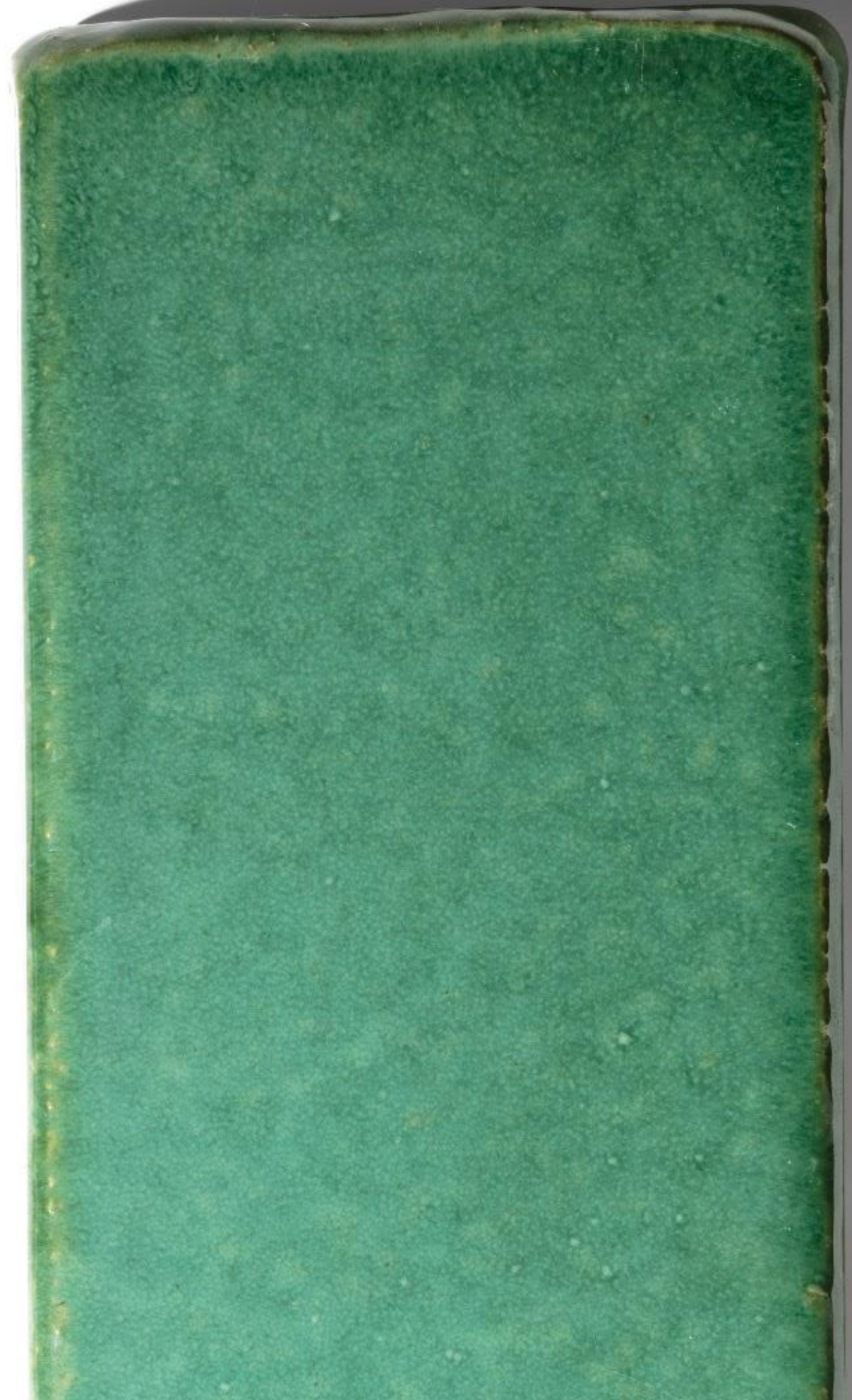

# Shelby Coffee Table



Introducing the 'Shelby Coffee Table' – a captivating blend of form and function. Inspired by the iconic design of its larger counterpart, the 'Shelby Dinner Table,' this coffee table brings a touch of artistry to your living space. Meticulously handcrafted ceramic surfaces meet sleek modern lines, creating a conversation piece that's as functional as it is elegant. Elevate your lounge area with the timeless sophistication of the 'Shelby Coffee Table' from Nestor & Rotsen.

*Designed by N&R Owner Devi Vervaeke*

# Shelby Coffee Table

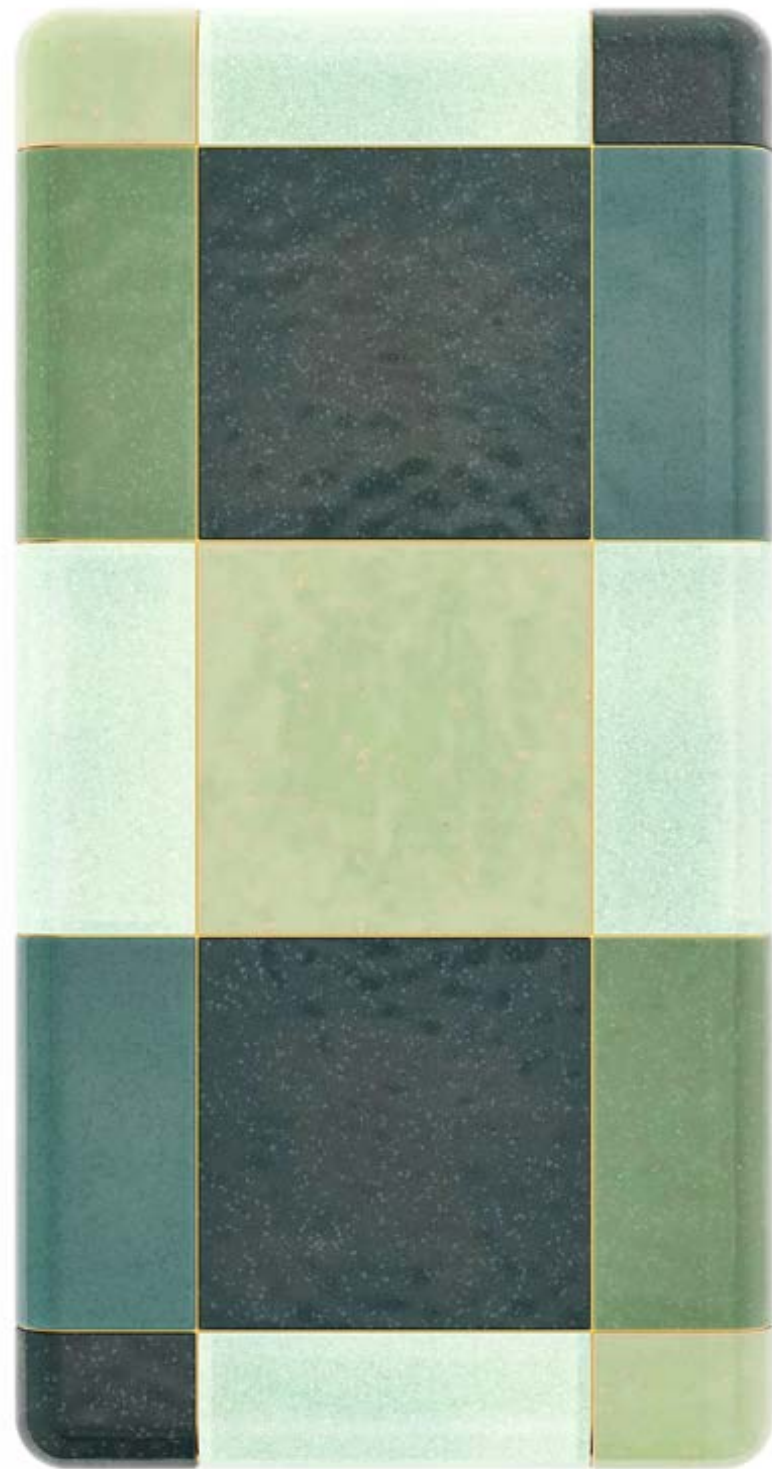

N&R

SEA  
FOAM  
TONES



N&R

# Shelby Coffee Table



# Shelby Coffee Table

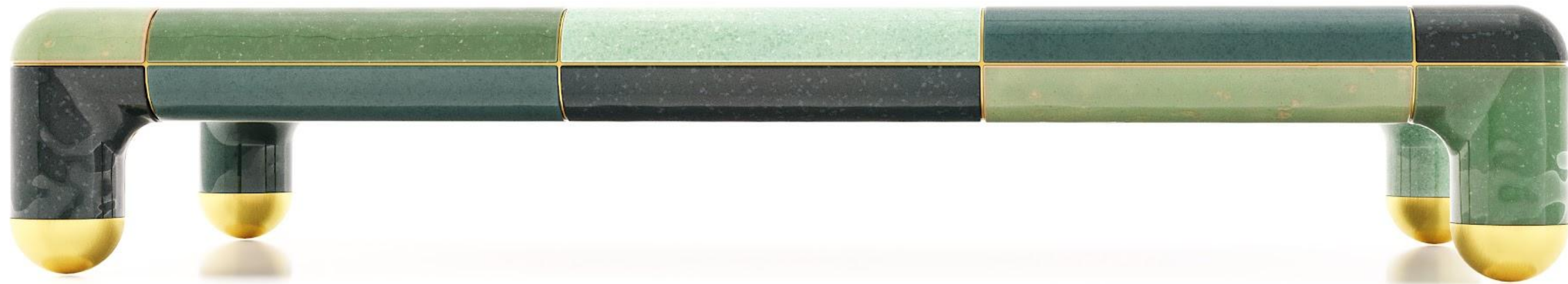

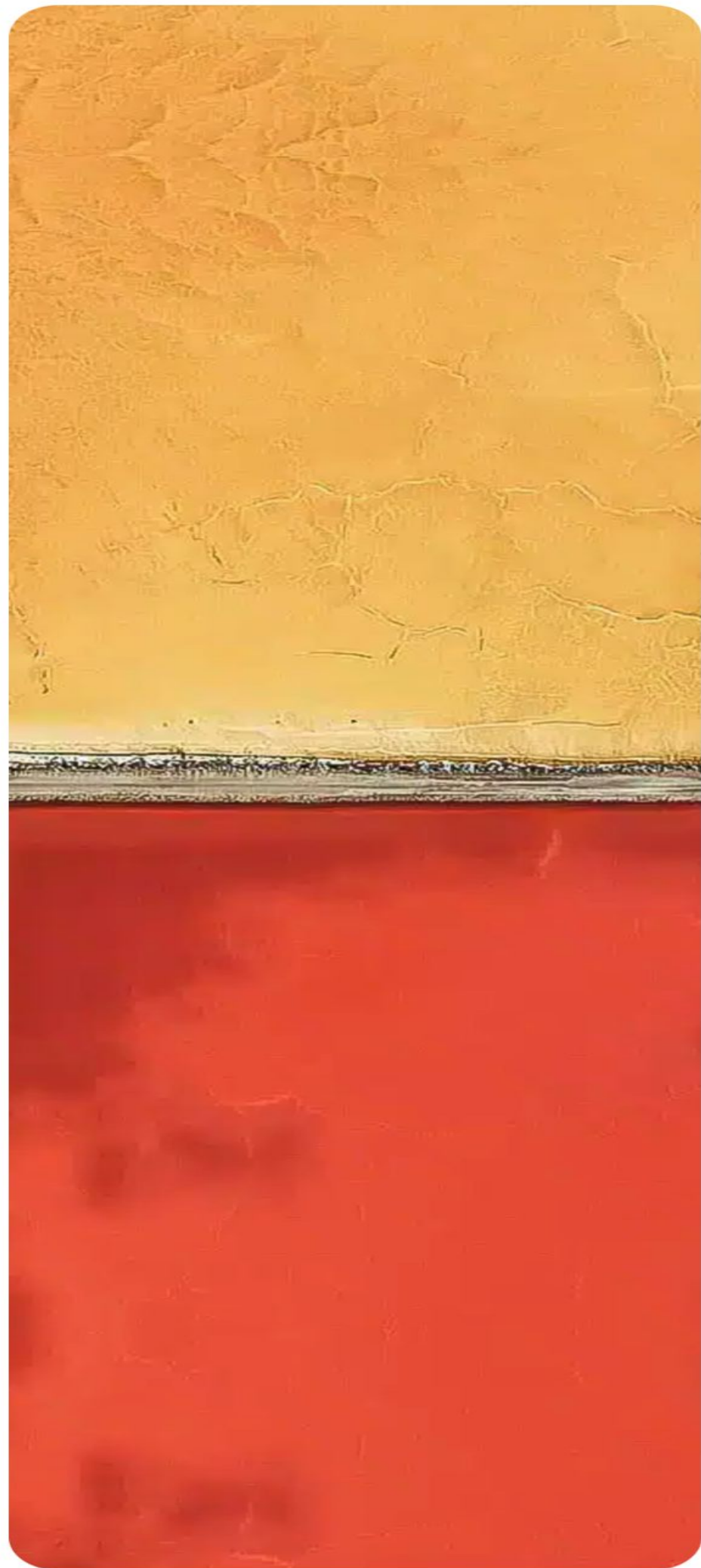

# LAVA TONES



# Shelby Coffee Table



# Shelby Coffee Table

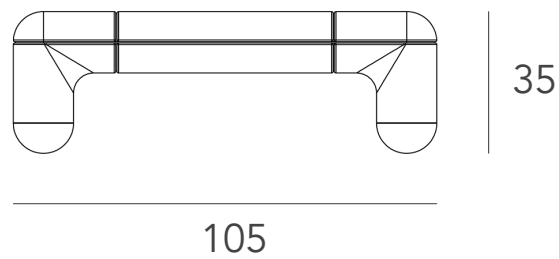
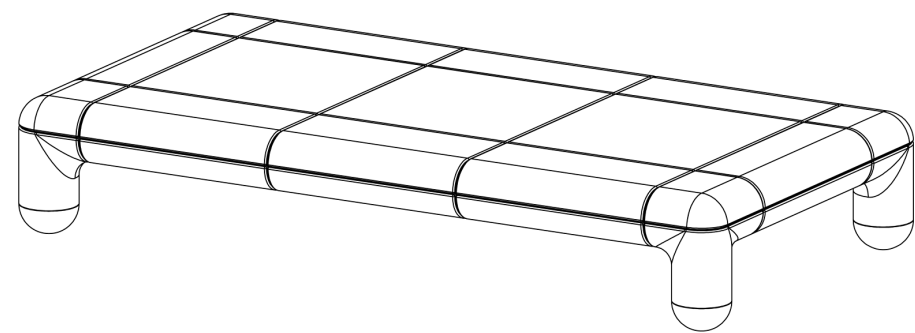
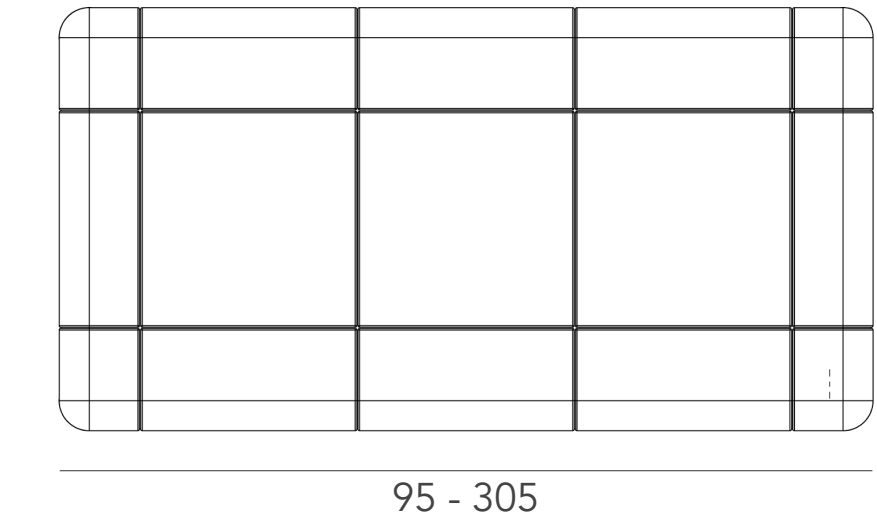

Technical drawing & Available colors

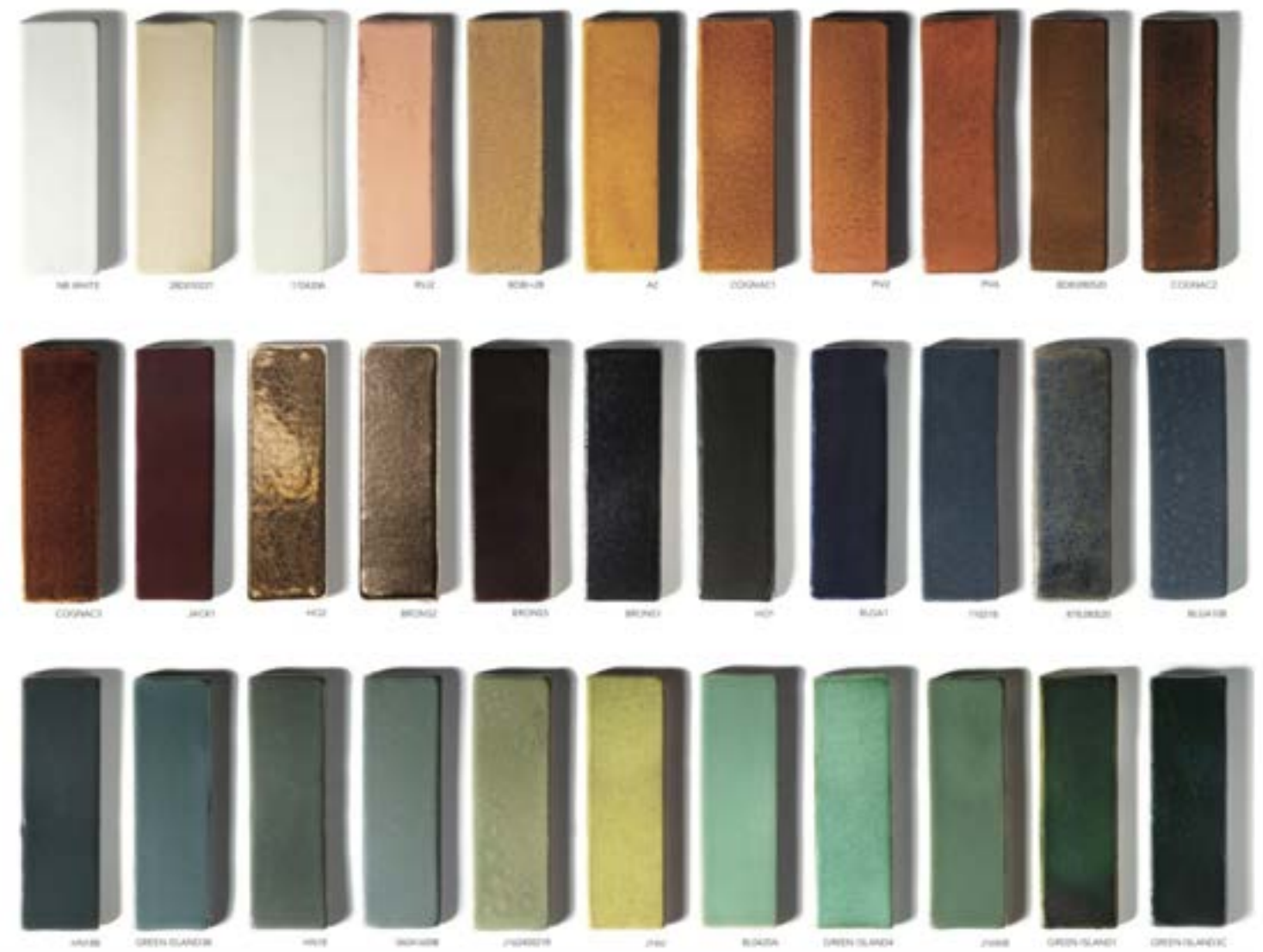



# Shelby Coffee Table

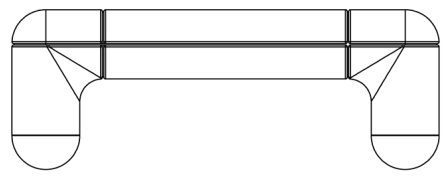

105

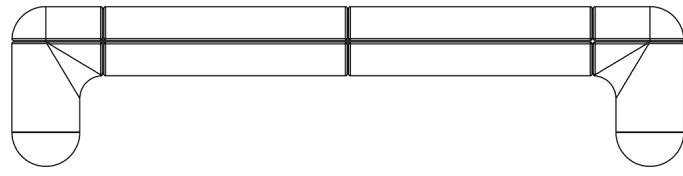

150

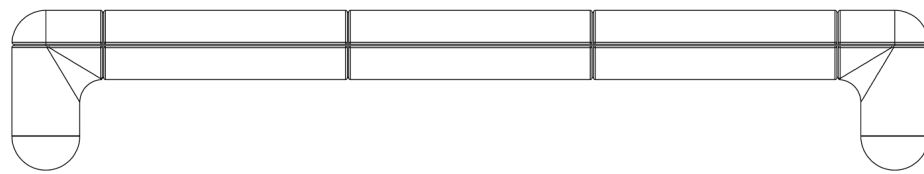

205

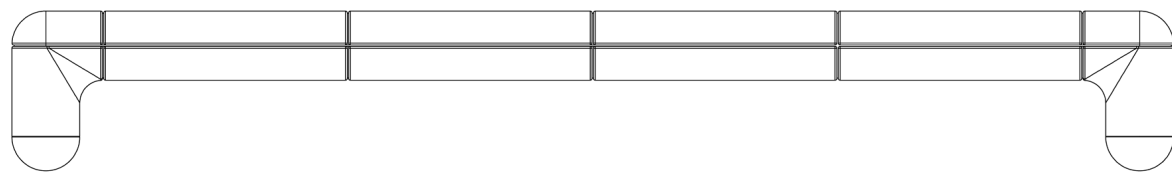

260

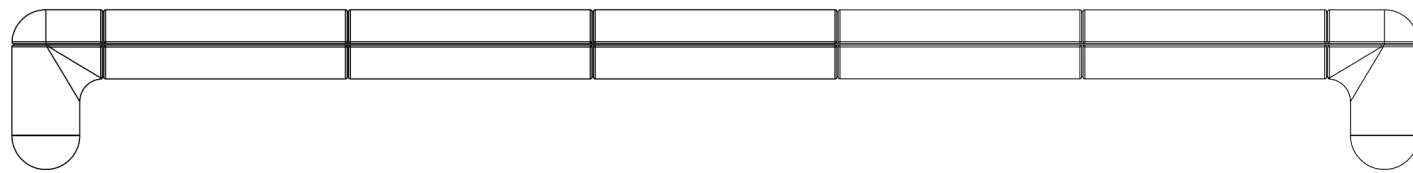

305

*Size in cm  
custom dimensions on request*

L. 105 | B. 95 | H. 35

L. 150 | B. 105 | H. 35

L. 205 | B. 105 | H. 35

L. 260 | B. 105 | H. 35

L. 305 | B. 105 | H. 35

# Shelby Coffee Table



*Size in cm  
custom dimensions on request*

*Price excl. VAT  
excl. transport*

L. 105 | B. 95 | H. 35

Prices on request

L. 150 | B. 105 | H. 35

L. 205 | B. 105 | H. 35

L. 260 | B. 105 | H. 35

L. 305 | B. 105 | H. 35

L. 360 | B. 105 | H. 35

# Shelby Hanging Cabinet



Elevate your walls with the 'Shelby Hanging Cabinet.' A symphony of graceful curves and impeccable craftsmanship, it transforms storage into art. Resonating with the spirit of the iconic 'Shelby' collection, this hanging cabinet exudes elegance from every angle. Its doors, with their beautifully rounded contours, invite you to uncover the treasures within.

Contrast this with our 'Linea' hanging cabinet, a sibling in our collection. While the 'Linea' boasts clean, sleek lines, the 'Shelby Hanging Cabinet' embraces the art of curvature, adding a touch of fluidity to your space. Whether you lean towards the bold geometry of the 'Linea' or the captivating rounded features of the 'Shelby Hanging Cabinet,' both offer a sophisticated solution for stylish storage.

Discover the perfect balance of form and function with the 'Shelby Hanging Cabinet.' Let your walls tell a story of design excellence and redefine elegance with Nestor & Rotsen.

*Designed by N&R Owner Devi Vervaeke*

# Shelby Hanging Cabinet



# Shelby Hanging Cabinet

## Inside finishes

Messing

Silver

Rose copper

Veneer



# Shelby Hanging Cabinet

Technical drawing & Available dimensions

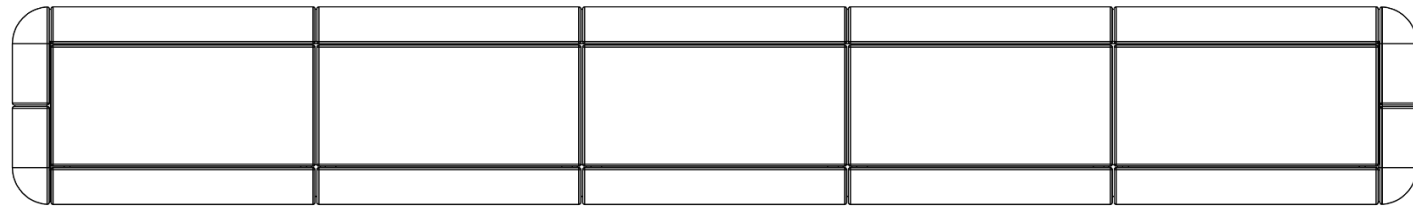

70 - 450

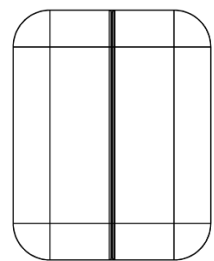
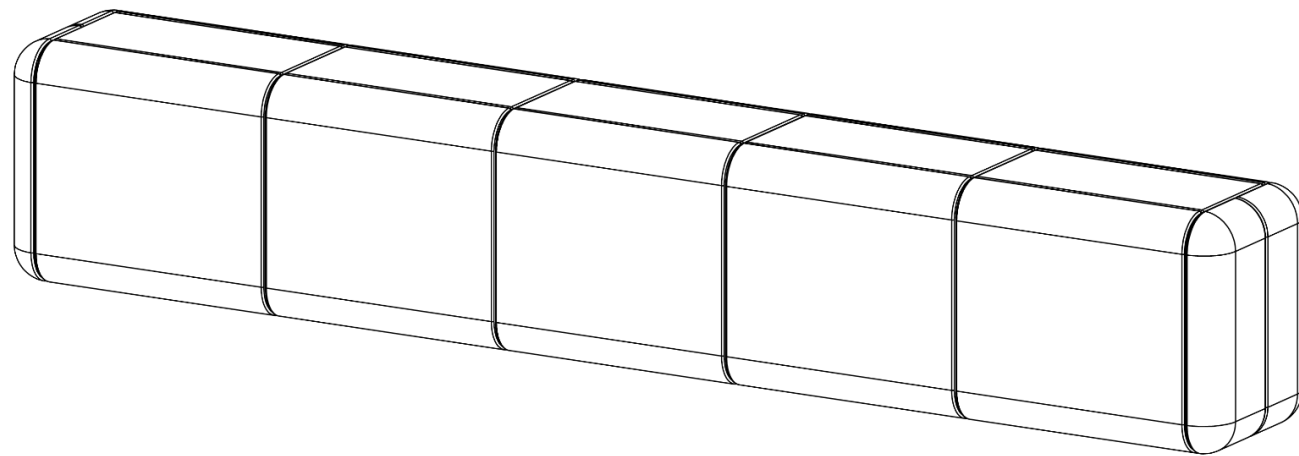

40

50

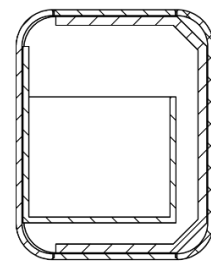

30  
SECTION A-A

26



# Shelby Hanging Cabinet

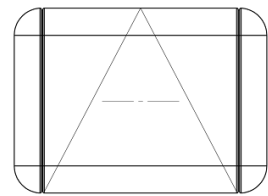

70

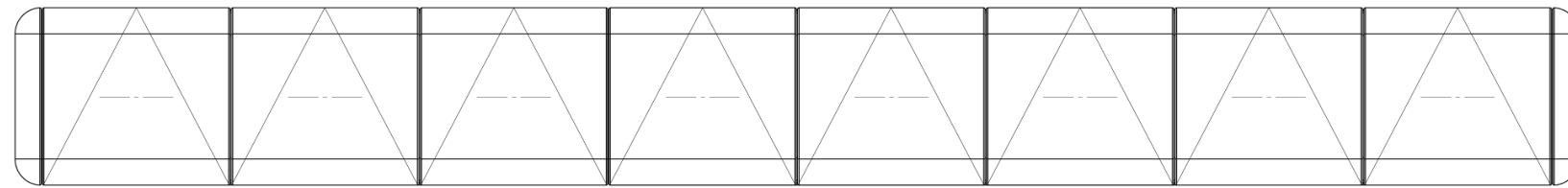

450

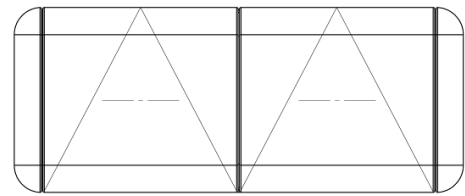

125

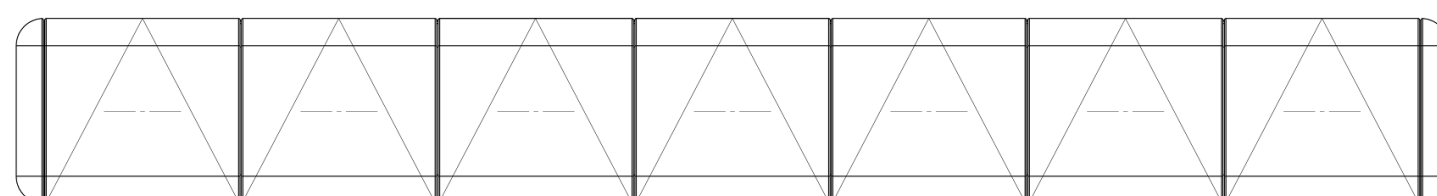

395

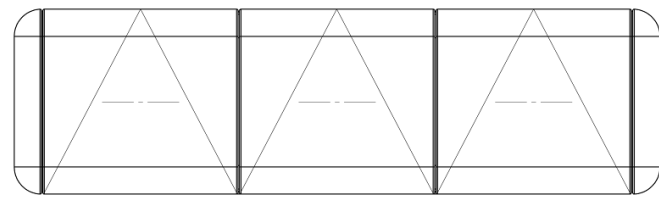

180

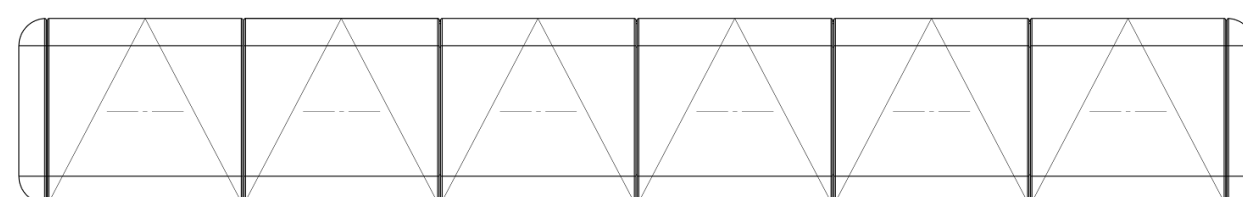

345

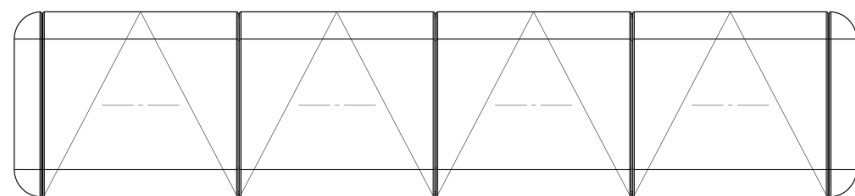

235

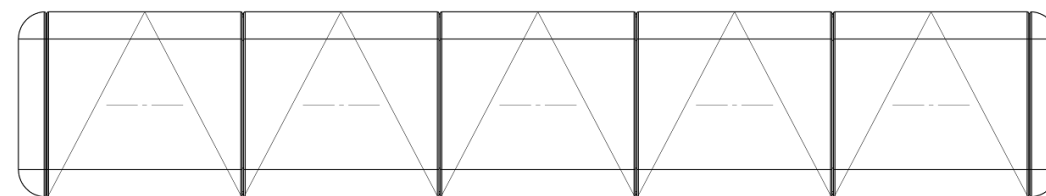

395

Size in cm  
custom dimensions on request

- L. 70 | B. 40 | H. 50  
1 door
- L. 125 | B. 40 | H. 50  
2 doors
- L. 180 | B. 40 | H. 50  
3 doors
- L. 235 | B. 40 | H. 50  
4 doors
- L. 290 | B. 40 | H. 50  
5 doors
- L. 345 | B. 40 | H. 50  
6 doors
- L. 395 | B. 40 | H. 50  
7 doors
- L. 450 | B. 40 | H. 50  
8 doors
- L. 505 | B. 40 | H. 50  
9 doors

# Shelby Hanging Cabinet



*Size in cm  
custom dimensions on request*

*Price excl. VAT  
excl. transport*

L. 70 | B. 40 | H. 50

1 door

L. 125 | B. 40 | H. 50

2 doors

L. 180 | B. 40 | H. 50

3 doors

L. 235 | B. 40 | H. 50

4 doors

L. 290 | B. 40 | H. 50

5 doors

L. 345 | B. 40 | H. 50

6 doors

L. 395 | B. 40 | H. 50

7 doors

L. 450 | B. 40 | H. 50

8 doors

L. 505 | B. 40 | H. 50

9 doors

Prices on request



# Shelby TV-unit



Unveil sophistication with the 'Shelby TV-unit' – a harmonious blend of design and functionality by Nestor & Rotsen. Crafted to capture the essence of the celebrated 'Shelby' collection, this floor cabinet boasts alluring curves and meticulous artistry. Its commanding presence adds a touch of refined elegance to your space, while offering discreet storage that seamlessly integrates with your interior.

In juxtaposition, meet our 'Linea Floor' cabinet – a contemporary sibling in our collection. With its sleek, linear profile, the 'Linea Floor' epitomizes modern minimalism that is both captivating and chic. The choice between the graceful contours of the 'Shelby TV-Unit' and the crisp lines of the 'Linea Floor' empowers you to shape a space that echoes your personal style.

Elevate your surroundings with the 'Shelby TV-unit.' Let it be a reflection of your discerning taste, as Nestor & Rotsen transforms everyday storage into a statement of sophistication. Redefine your interiors with our exceptional designs.

*Designed by N&R Owner Devi Vervaeke*



N 42 R



# RIVER TONES



N & R

# Shelby TV-unit



# Shelby TV-unit

## Inside finishes & feet

Messing

Silver

Rose copper



# Shelby TV-unit

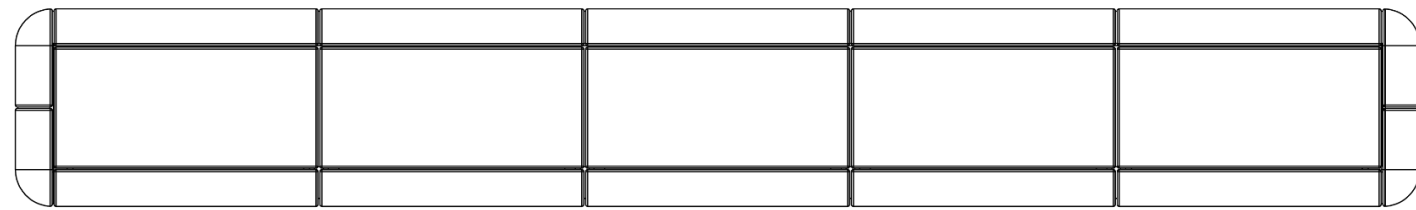

70-450

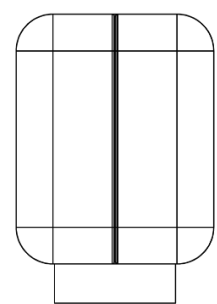
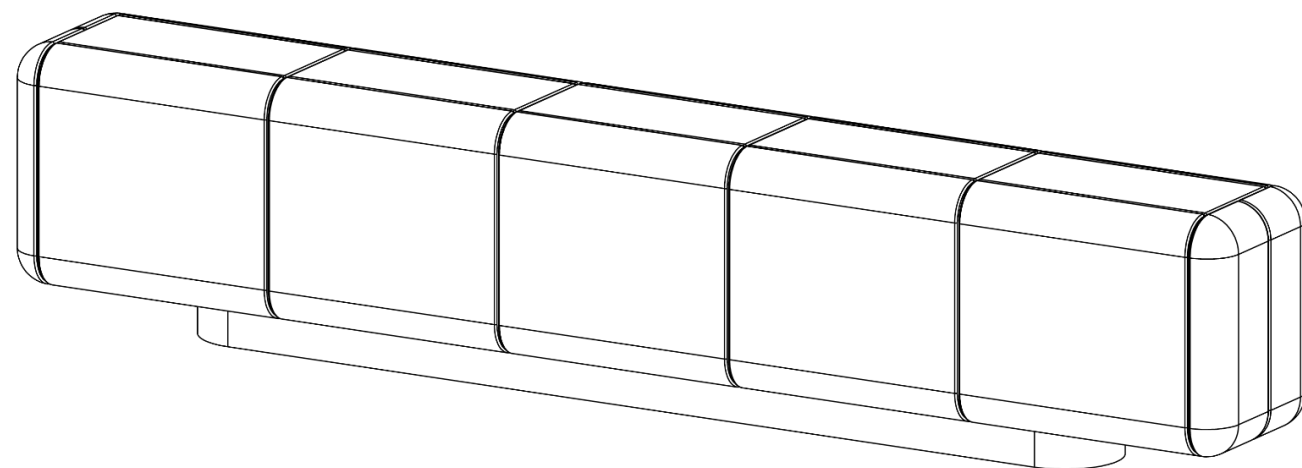

40



50

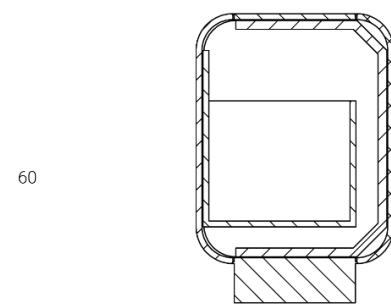

26

30  
SECTION A-A

Technical drawing & Available colors

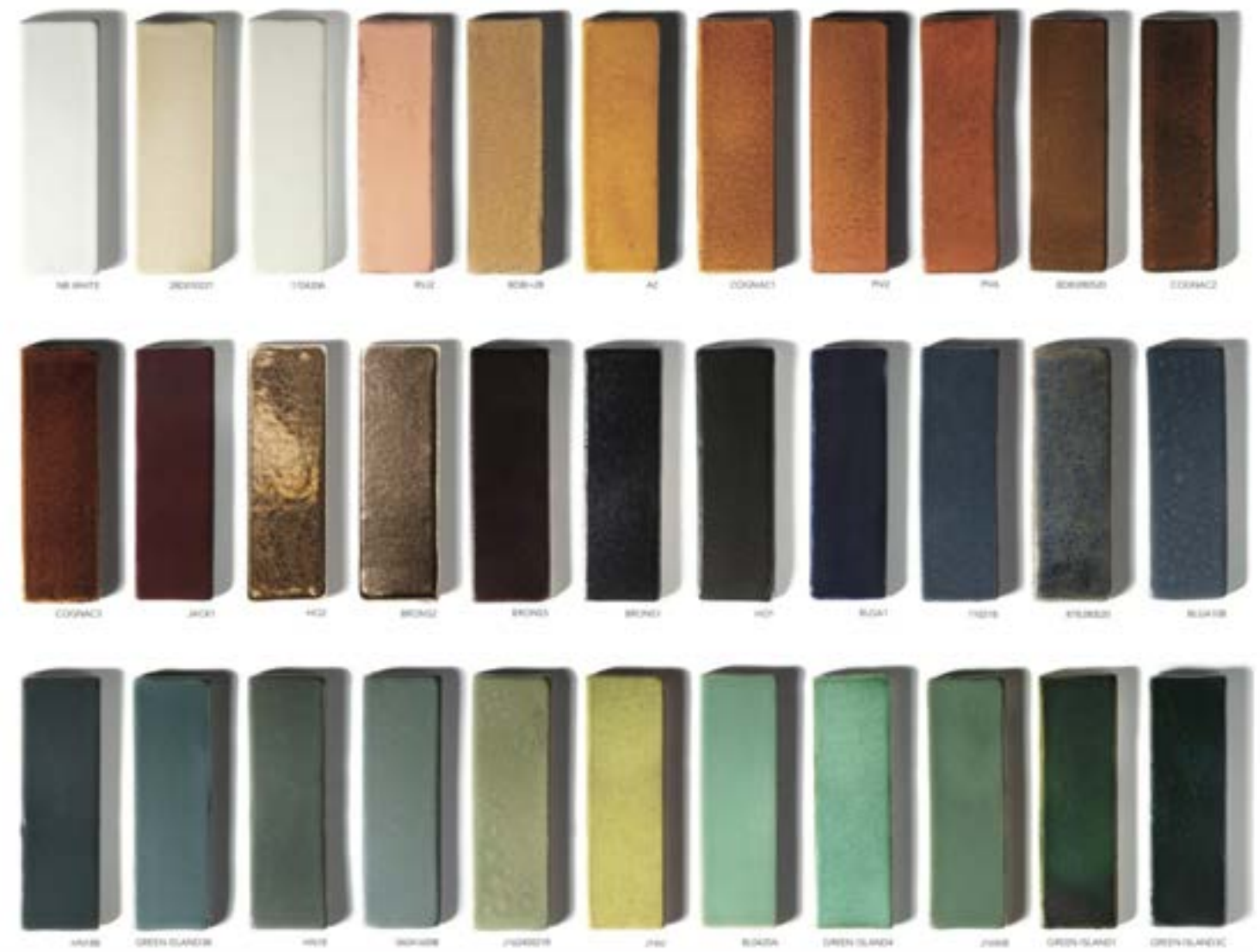

# Shelby Hanging Cabinet

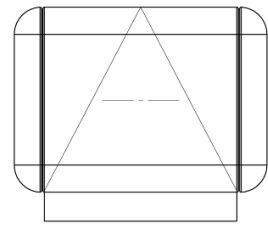

70

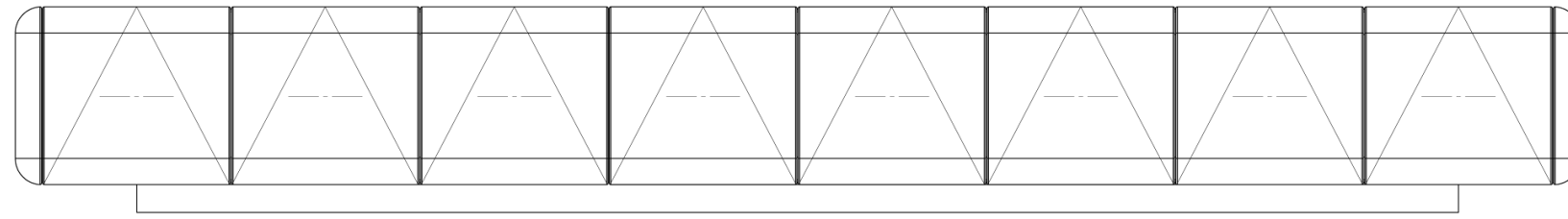

450

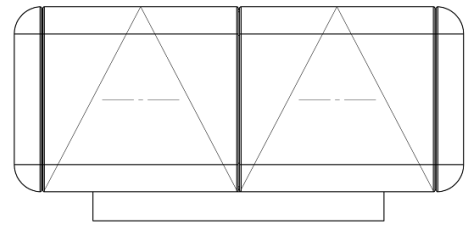

125

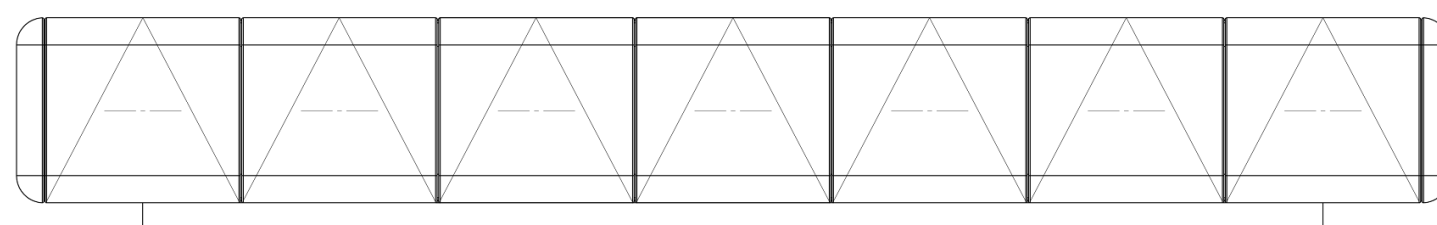

395

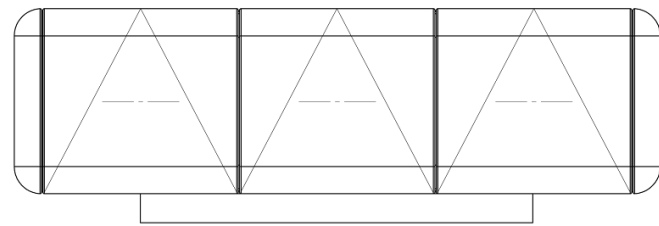

180

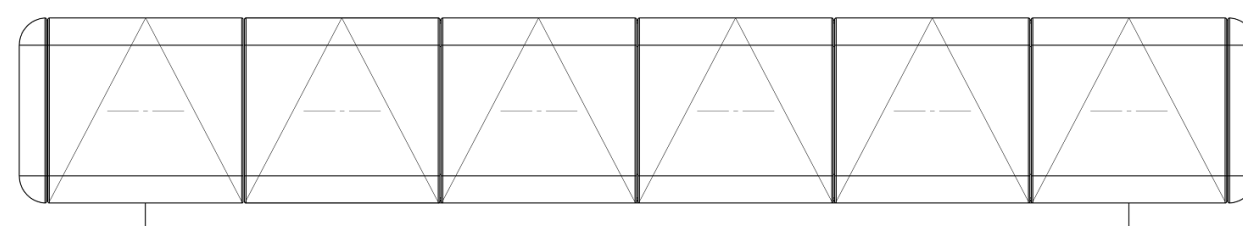

345

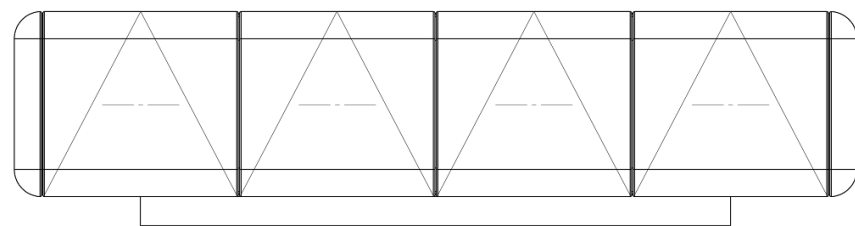

235

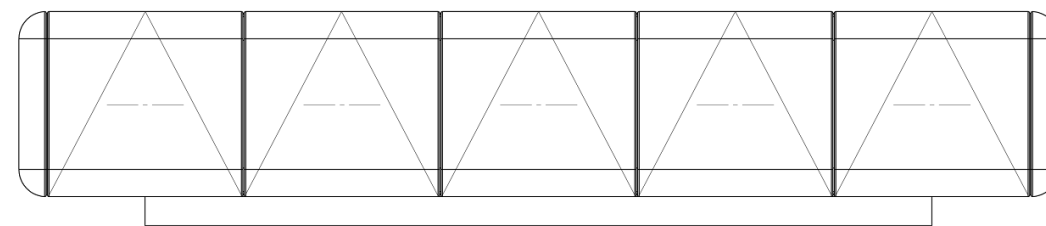

395

*Size in cm  
custom dimensions on request*

L. 70 | B. 40 | H. 60

1 door

L. 125 | B. 40 | H. 60

2 doors

L. 180 | B. 40 | H. 60

3 doors

L. 235 | B. 40 | H. 60

4 doors

L. 290 | B. 40 | H. 60

5 doors

L. 345 | B. 40 | H. 60

6 doors

L. 395 | B. 40 | H. 60

7 doors

L. 450 | B. 40 | H. 60

8 doors

L. 505 | B. 40 | H. 60

9 doors

# Shelby TV-unit



*Size in cm  
custom dimensions on request*

*Price excl. VAT  
excl. transport*

L. 70 | B. 40 | H. 60

Prices on request

1 door

L. 125 | B. 40 | H. 60

2 doors

L. 180 | B. 40 | H. 60

3 doors

L. 235 | B. 40 | H. 60

4 doors

L. 290 | B. 40 | H. 60

5 doors

L. 345 | B. 40 | H. 60

6 doors

L. 395 | B. 40 | H. 60

7 doors

L. 450 | B. 40 | H. 60

8 doors

L. 505 | B. 40 | H. 60

9 doors

# Video Library



Please check out the Shelby Video on our website through the following link:

<https://nestor-rotsen.eu/video-library/>

# Ceramic Samples





**Flag store**

Dorpsstraat 50-52  
9831 Deurle/Sint Martens Latem  
Belgium

[www.nestor-rotsen.eu](http://www.nestor-rotsen.eu)  
[studio@nestor-rotsen.eu](mailto:studio@nestor-rotsen.eu)  
0032 (0) 485 085 382

**Workshop**

Akkerstraat 1/1A  
8020 Oostkamp/Waardamme  
Belgium

**Follow**

IG: @nestor\_rotsen

**Delivery**

All countries  
Express production: ex-works...days  
after confirmation

Payment conditions  
All countries Payment in advance with  
proforma

**Important**

Shape, texture and color variation are  
inherent characteristics of handcrafted  
pieces. The unique beauty of your N&R  
object is enhanced by such variation  
and cannot be a ground for complaint.

We cannot be held liable for any  
discrepancies between the images and  
descriptions given and the actual  
product. Please be aware that colors  
may vary from those shown in this  
document.

Our General Terms are available on  
demand.

NESTOR&ROTSEN © 2021\_1.1

NESTOR & ROTSSEN

**Photography**

Koen Vandamme

**Copyrighting**

Nestor & Rotsen

**Graphic design**

Nestor & Rotsen

January 2022

The details provided in this document were correct at the time of publication. They do not constitute any kind of obligation on our part and are for information only. We reserve the right to alter material, dimensions and characteristics at any time. We cannot be held liable for any discrepancies between the images and descriptions given and the actual product. Please be aware that actual colors may vary from those shown in this document.